

# Gas-Pro

## User & Operator Manual

H<sub>2</sub>S  
CO  
CH<sub>4</sub>



### Gas-Pro

Multi-gas monitor



**CROWCON**  
Detecting Gas Saving Lives

**BE** SAFE  
POSITIVE  
**+ve Safety™**

M07995/Eng  
Issue 10 Apr 2016

# NAVIGATION INSTRUCTIONS

The symbols in the left-hand margin of each page of the manual will enable you to carry out the following functions:

 Click on this button to display the Contents page.



Click on this button to display the previous page.



Click on this button to display the next page.



Click on this button to display the previous view (use it to return from a reference jump).



Click on this button to display next view (use it to return to a reference jump).



Click this button to print some or all of the document (specific pages can be chosen).

 Exit

Click this button to exit the User and Operator Manual.













**Press the Esc key to display normal Acrobat® Controls.**

# CONTENTS

---

<b>PROLOGUE</b> .....	<b>7</b>
<b>Gas-Pro Overview</b> .....	<b>7</b>
<b>Safety Information</b> .....	<b>8</b>
<b>Unpacking</b> .....	<b>11</b>
<b>1. Set-up</b> .....	<b>12</b>
<b>1.1 Prior to use</b> .....	<b>12</b>
<b>1.2 Gas-Pro orientation</b> .....	<b>12</b>
<b>1.3 Charging</b> .....	<b>13</b>
<b>1.4 Fitting a flow plate</b> .....	<b>14</b>
<b>1.5 Quick view</b> .....	<b>15</b>
<b>2. Operation</b> .....	<b>16</b>
<b>2.1 General</b> .....	<b>16</b>
<b>2.2 Turn on</b> .....	<b>16</b>
<b>2.3 Pump test</b> .....	<b>20</b>
<b>2.4 Detecting gas</b> .....	<b>21</b>
<b>2.4.1 Diffusion monitoring</b> .....	<b>21</b>
<b>2.4.2 Pumped mode</b> .....	<b>22</b>
<b>2.4.3 Manual sampling</b> .....	<b>23</b>
2.4.3.1 Using the Hand Aspirator .....	<b>23</b>
<b>2.5 Alarms</b> .....	<b>24</b>
<b>2.5.1 Low battery alarm</b> .....	<b>24</b>
<b>2.5.2 Instantaneous alarm</b> .....	<b>24</b>
<b>2.5.3 Time weighted average alarm (TWA)</b> .....	<b>24</b>
<b>2.5.4 Accepting and clearing alarms</b> .....	<b>25</b>

<b>2.5.5 Sensor types</b> .....	<b>25</b>
2.5.5.1 Oxygen sensors .....	25
2.5.5.2 Electro-chemical sensors .....	25
2.5.5.3 Infra red sensors .....	25
2.5.5.4 Pellistor sensors .....	26
2.5.5.5 Pellistor saver mode  .....	26
2.5.5.6 PID .....	27
<b>2.6 Gas-Pro functions</b> .....	<b>28</b>
<b>2.6.1 Accessing the user menus</b> .....	<b>28</b>
<b>2.6.2 Home screen</b>  .....	<b>28</b>
<b>2.6.3 Manual zero</b>  .....	<b>28</b>
<b>2.6.4 Time weighted average</b>  .....	<b>28</b>
<b>2.6.5 Pre-entry check (PEC)</b>  .....	<b>29</b>
2.6.5.1 Starting a Pre-entry check .....	29
2.6.5.2 Carrying out a Pre-entry check .....	30
<b>2.6.6 Peak review</b>  .....	<b>31</b>
<b>2.6.7 Settings</b>  .....	<b>31</b>
2.6.7.1 User setting  .....	31
2.6.7.2 Pump setting  .....	31
2.6.7.3 Sounder volume  .....	31
<b>2.7 Shut down</b> .....	<b>32</b>
<b>2.8 Additional Features</b> .....	<b>32</b>
<b>2.8.1 +ve Safety™</b> .....	<b>32</b>
2.8.1.1 +ve Safety™ indicator meanings .....	32
<b>2.8.2 Data and event logging</b> .....	<b>33</b>
<b>2.8.3 Bump/Pump functionality</b> .....	<b>33</b>

<b>2.9 Tank Check Mode</b> .....	<b>34</b>
<b>2.9.1 Dual-Range Operation</b> .....	<b>35</b>
<b>2.9.2 Differences with Home Screen</b> .....	<b>35</b>
2.9.2.1 Instantaneous Alarms .....	35
2.9.2.2 TWA .....	35
2.9.2.3 Pre-Entry Check (PEC) .....	35
2.9.2.4 Confidence Tone .....	36
2.9.2.5 Display Backlight .....	36
<b>3. Gas testing and calibration</b> .....	<b>37</b>
<b>3.1 Introduction</b> .....	<b>37</b>
<b>3.2 Bump Test Functionality</b> .....	<b>38</b>
<b>3.2.1 Speedy bump</b> .....	<b>39</b>
3.2.1.1 Procedure .....	39
<b>3.2.2 Smart bump</b> .....	<b>39</b>
3.2.2.1 Procedure .....	39
<b>3.2.3 Calibration after bump fail</b> .....	<b>40</b>
3.2.3.1 Procedure .....	40
<b>3.3 New sensor calibration/service</b> .....	<b>40</b>
<b>3.4 Gas test screen flow</b> .....	<b>41</b>
<b>4. Icon overview</b> .....	<b>42</b>
<b>5. Service and maintenance</b> .....	<b>43</b>
<b>6. PC interface and Portables Pro</b> .....	<b>44</b>
<b>6.1 General</b> .....	<b>44</b>
<b>6.2 PC interface cable</b> .....	<b>44</b>
<b>7. Accessories</b> .....	<b>45</b>

<b>8. Specification</b> . . . . .	<b>47</b>
<b>9. Troubleshooting</b> . . . . .	<b>48</b>
<b>9.1 Pump test failure</b> . . . . .	<b>48</b>
<b>9.2 Fault screens</b> . . . . .	<b>48</b>
<b>9.2.1 Fault Descriptions</b> . . . . .	<b>49</b>
<b>9.2.2 Fault codes</b> . . . . .	<b>51</b>
<b>10.Appendices</b> . . . . .	<b>52</b>
<b>10.1 Sensors</b> . . . . .	<b>52</b>
<b>10.1.1 Toxic</b> . . . . .	<b>52</b>
<b>10.1.2 Flammable Pellistor Sensors</b> . . . . .	<b>53</b>
<b>10.1.3 Flammable IR Sensors</b> . . . . .	<b>53</b>
<b>10.1.4 Oxygen</b> . . . . .	<b>53</b>
<b>10.1.5 IR</b> . . . . .	<b>53</b>
<b>10.1.6 PID</b> . . . . .	<b>53</b>
<b>10.2 Sensor Limitations</b> . . . . .	<b>54</b>
<b>10.3 Charging and run times</b> . . . . .	<b>55</b>
<b>10.4 Contacts</b> . . . . .	<b>56</b>
<b>Warranty</b> . . . . .	<b>57</b>

# PROLOGUE

## **Gas-Pro Overview**

Thank you for purchasing the new Gas-Pro. At Crowcon we recognise the need for reliable and robust personal monitors which are sized to be worn and simple to use.

Gas-Pro is a portable monitor capable of detecting up to 5 gases in a compact and wearable design featuring an optional internal pump. Focused on users and fleet managers alike, Gas-Pro offers application focused solutions giving greater operating time and reduced set up time.

Gas-Pro is classified for use in hazardous areas and gives loud and bright audible and visual alarm indications as well as a vibrate alert. The top mount display is backlit for ease of use, and the simple single button solution makes using and training quick and easy.

# Safety Information

- Gas-Pro is a hazardous area certified gas detector and as such must be operated and maintained in strict accordance with the instructions, warnings and label information included in this manual. Gas-Pro must be operated within the limitations stated.
- Read and understand all instructions in the operation section of this manual prior to use.
- Before use ensure that the equipment is in good condition, the enclosure is intact has not been damaged in any way.
- If there is any damage to the equipment do not use, contact your local office or agent for repair/ replacement.
- Do not disassemble or substitute components as this may impair intrinsic safety and invalidate safety certification.
- Only genuine replacement parts must be used; substitute components may invalidate certification and warranty of the Gas-Pro and accessories, reference “Service and Maintenance” section for details.
- No live maintenance is permissible.
- Observe all warnings and instructions marked on the unit and within this manual.
- Observe site health and safety procedures for gases being monitored and evacuation procedures.
- Understand the screen display and alarm warnings prior to use.
- If this product is not working properly, read the troubleshooting guide and/or contact your local office or agent, for details reference the ‘Contacts’ section of the manual (see [page 52](#)).
- Ensure maintenance, service and calibration is carried out in accordance with the procedures in the manual and only by trained personnel.
- The Gas-Pro re-chargeable battery must only be charged in non-hazardous (safe) areas.
- Only connect to Gas-Pro in a safe area for charging or communications.
- Gas-Pro must not be charged or have communication to the device, at ambient temperatures greater than +40°C.
- Charging cable assemblies, whilst nominally providing a voltage of 6.5V, must not exceed a voltage of 9.1V as this may impair intrinsic safety and invalidate safety certification (Um=9.1V).
- Communication cable assemblies, whilst nominally operating at a voltage of 3.0V TTL, must not exceed a voltage of 9.1V as this may impair intrinsic safety and invalidate safety certification (Um=9.1V).
- The devices are intended for use in normal atmospheric conditions of temperature –20 °C to +55 °C; pressure 80 kPa (0,8 bar) to 110 kPa (1,1 bar); and air with normal oxygen content, typically 21 % v/v (volume/volume).



- Gas-Pro may be used in Zones 1 and 2, for Group IIA, IIB and IIC gases and vapours and for Temperature Classes T1, T2, T3 and T4. (see Certification labels below).
- **Certification labels**  
The certification marking is as follows:

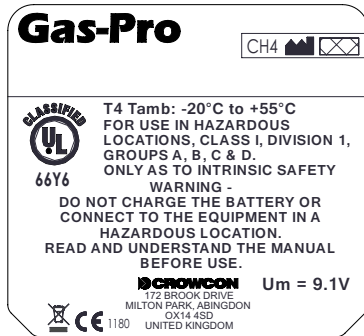

UL certification label

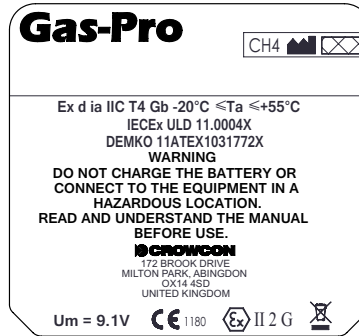

ATEX/IECEx certification label

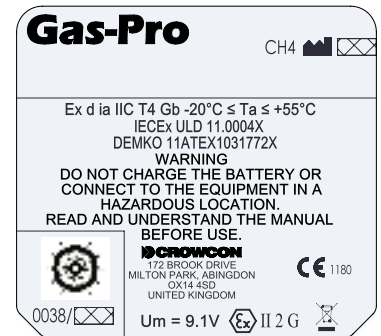

MED certification label

- Gas-Pro is certified for use in ambient temperatures in the range -20°C to +55°C (-4 to 131°F).
- Applicable Standards  
Refer to equipment marking for confirmation of applicable certification before use.

### IECEx

IEC 60079-0: 2013, 6th Edition

Explosive atmospheres – Part 0: Equipment - General requirements

IEC 60079-1:2007, 6th Edition

Explosive atmospheres – Part 1: Equipment protection by flameproof enclosures “d”

IEC 60079-11: 2012, 6th Edition

Explosive atmospheres - Part 11: Equipment protection by intrinsic safety “i”

Ex d ia IIC T4 Gb Tamb -20°C to +55°C

IECEx ULD 11.0004X

## **ATEX**

EN 60079-0: 2012 + A11: 2013

Explosive atmospheres – Part 0: Equipment - General requirements

EN 60079-1:2007

Explosive atmospheres – Part 1: Equipment protection by flameproof enclosures “d”

EN 60079-11: 2012

Explosive atmospheres - Part 11: Equipment protection by intrinsic safety “i”



II 2 G Ex d ia IIC T4 Gb Tamb -20°C to +55°C

DEMKO 11 ATEX 1031772X

## **UL**

Gas detector use in hazardous locations Class 1 Division 1, Groups A, B, C and D only as to intrinsic safety.

UL 913

Applicable Edition of the UL standard

UL60079-0

Applicable Edition of the UL standard

UL60079-11

Applicable Edition of the UL standard

# Unpacking

Remove the Gas-Pro from the packaging. The standard accessories are under the supporting trays. The following items will be included as standard:

## Box contents

- Gas-Pro
- Quick Start Guide
- CD Manual
- Calibration report

The following items are optional:

## Optional items

- Charger cradle
- Charger lead (see Power & Communication Cables Technical Data)
- Flow plate (standard for pumped units)

**If you have ordered a charger and/or cradle this will also be included in the box. Further accessories are available but will not be contained in the box (see [Section 7](#)).**

**Gas-Pro in the off state can be left on charge indefinitely**

**Should the unit be deep discharged, the charging indication will not be shown until the unit has been charging for 1 hour and the operator button has been pressed.**

**When on and charging a warning will advise the user to turn the Gas-Pro off after 12 hours or remove from charge.**

**Store the battery in a full state and recharge at least once every 3 months.**

# 1. Set-up

## 1.1 Prior to use

Before use, the Gas-Pro should always be checked for any signs of physical damage.

Gas-Pro uses a Lithium Ion (Li-ion) battery pack and should arrive with sufficient charge to be used straight out the box. However, if this is the first time of use, you may need to charge the battery to attain the full operating time (see [Charging](#) on [page 13](#)).

For battery run times, see the table on [page 55](#).

**The actual operating time will depend on the types of sensor installed.**

## 1.2 Gas-Pro orientation

Figure 1: Gas-Pro

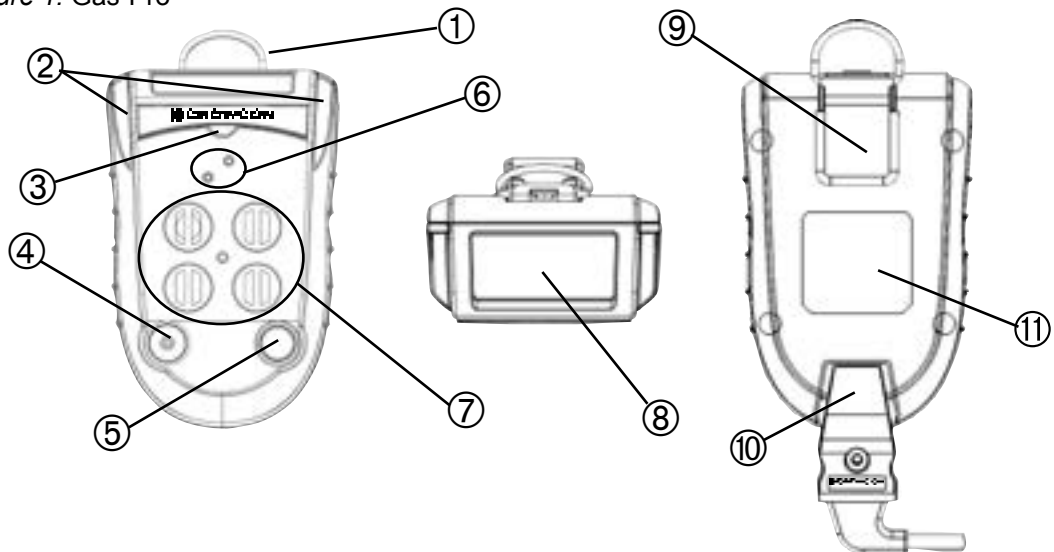

① D-ring

② Alarm bars

③ +ve Safety™ indicator

④ Sounder

⑤ Operator button

⑥ Pump inlet/outlet\*

⑦ Sensor apertures

⑧ Dual colour LCD display

⑨ Alligator clip

⑩ Charging cable

⑪ Certification label

\* Blanked for non-pumped unit.

## 1.3 Charging

Charging should only take place in non-hazardous (safe) areas. To charge, simply plug the cable ① into the charging socket ② on the Gas-Pro and turn on the mains supply (see [Figure 2](#) below). If a charging cradle or vehicle cradle is being used, ensure the Gas-Pro fits firmly on to the power connector.

**The charger must be able to supply 6.5V@ 450mA with an output voltage that does not exceed 9.1V (Um).**

*Figure 2: Charger connection*

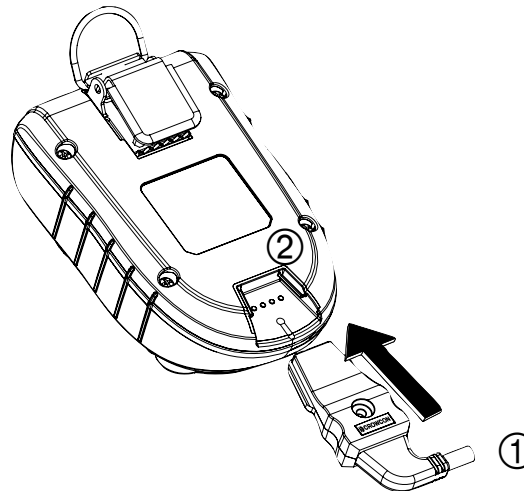

When off, to show the Gas-Pro is charging, both LEDs within the alarm bars will flash red and will change to green once fully charged. This state will continue until the trickle charge is complete. Charging will then terminate showing no indication. The screen will also show the battery icon filling in the middle of the screen when the Gas-Pro is off, and in the bottom left-hand corner when it is on. The battery icon contains a maximum of six segments to indicate the battery's state of charge. For example, with three segments shown and a fourth flashing, the battery is 50% charged ①, and when all six are shown, the battery is fully charged ② (see [Figure 3](#) below).

*Figure 3: Charging indications*

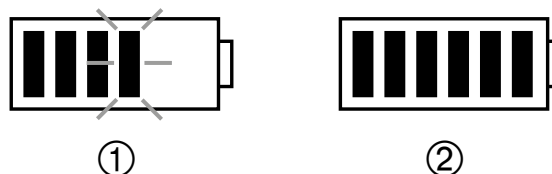

## 1.4 Fitting a flow plate

A flow plate can be used for a number of applications including pumped operation (remote sampling), manual gas test/calibration or for manual sampling. If the pumped flow plate is attached before turning the Gas-Pro on and the Gas-Pro includes a pump, a pump test will commence as part of the start up process (see [Pump test](#) on [page 20](#)).

There are 3 types of flow plate: one for a Gas-Pro with internal pump, one for a Gas-Pro with no pump and a non-magnetic version for PC calibration or for manual sampling. Although there is no difference to the attachment procedure, they are not interchangeable (see [Figure 4](#)). The pumped flow plate has the  symbol in the top left corner to aid recognition.

*Figure 4: Pumped and non pumped flow plates*

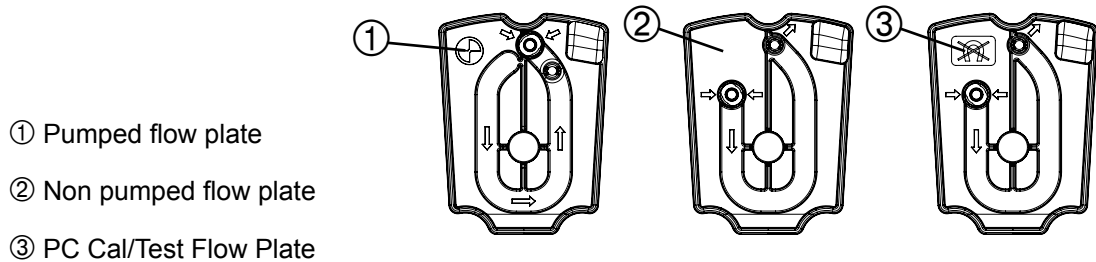

Check the flow plate's gasket is free from dirt and has not been damaged prior to fitting. To fit a flow plate, locate it over the Gas-Pro sensors as shown in [Figure 5](#) and tighten the securing screw ①.

*Figure 5: Fitting a flow plate*

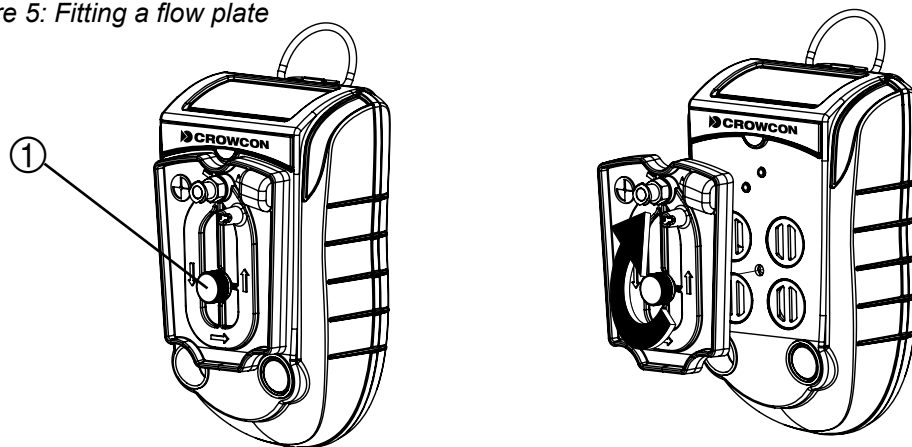

The flow plate includes a quick connect fitting for attaching sample tubes and probes.

## 1.5 Quick view

Even when the detector is off, users can display details about the configuration of the Gas-Pro by momentarily pressing the operator button for one audible blip. The LED to the left of the display will flash red once and the Quick view screen shown in [Figure 6](#) below will be displayed for 10 seconds.

*Figure 6: Quick view display*

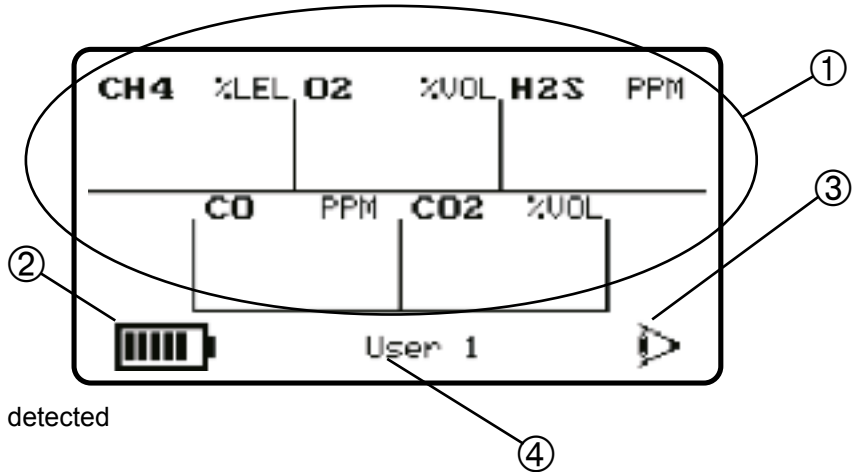

- ① Gas type and unit detected
- ② Battery status
- ③ Quickview icon
- ④ ID or serial number

**i** The +ve Safety™ LED status is also shown (see [Figure 1](#)).

## 2. Operation

### 2.1 General

- ! Before turning the Gas-Pro on, ensure it is in 'clean air' (i.e. outside, in normal air, away from any plant process or suspected gas location). This will allow the Gas-Pro to be zeroed using clean air as the base point. If the Gas-Pro is zeroed in contaminated air a false gas reading can result, or the zero could fail.

### 2.2 Turn on

In 'clean air', turn on the Gas-Pro by holding down the operator button for 3 audible blips. The Gas-Pro will warm up, going through a series of automatic processes as follows:

Firstly a test screen pattern will be generated. Watch this to ensure there are no missing pixels on your display screen.

Whilst the Gas-Pro is warming up, two screens will be displayed.

Figure 7: Initial screens at turn on

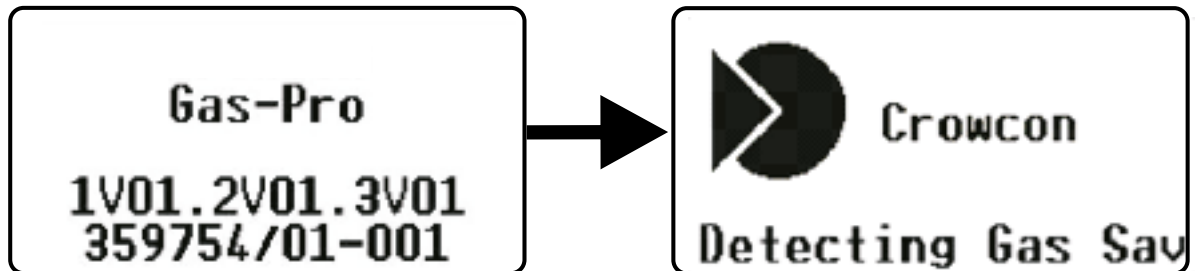

After a successful test cycle the LCD screen will remain green, the sounder and LEDs will indicate the Gas-Pro is healthy.

- ! A Gas-Pro fitted with a pump is configured as standard to start the pump automatically when switched on, provided that a flow plate is fitted. Such a Gas-Pro tests the pump automatically at this point (for more details on this, see [Pump test](#) on page 20).
- ! If the battery level is low, an alarm will sound, and the battery icon on the screen will be partial.
- ! If a second 'splash' screen has been configured via Portables Pro it will be shown next in the turn on sequence.



If the Gas-Pro is configured for regular Gas Testing (Bump Test), the date of the last Gas Test will also be shown (for more information on Gas Testing, see [Gas testing and calibration](#) on [page 37](#)).

Figure 8: Gas test due screen

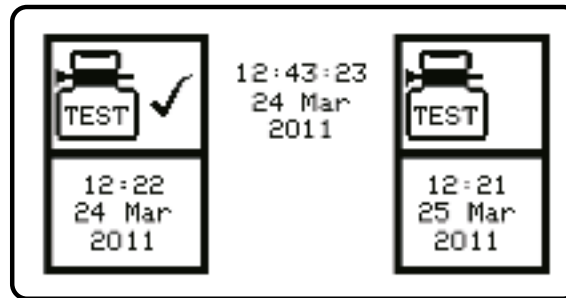



The next screen indicates when the Gas-Pro was last calibrated. It also indicates when the next calibration is due with a warning symbol  next to the number of days left, if this is fewer than 30 days. If the calibration due date has expired, the number of days figure is not displayed and the warning symbol flashes.

Figure 9: Calibration due screen

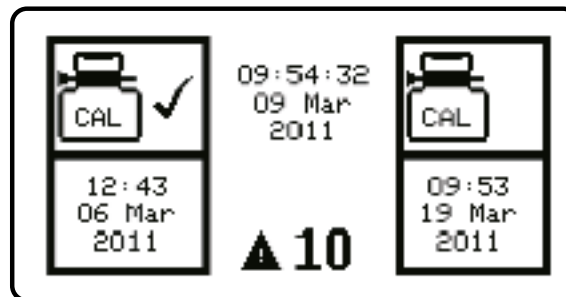

If the calibration due lockout feature has been enabled the lockout icon  will be displayed and the Gas-Pro will not proceed past this point.

The next screen (*Figure 10*) will display the current detector settings (for more information on these settings, see *Gas-Pro functions* on *page 28*).

*Figure 10: Current settings screen*

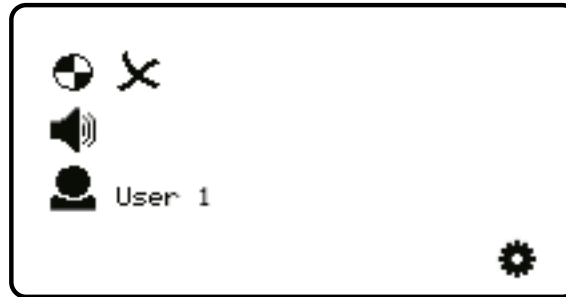

The Autozero Confirm screen will be displayed next.

*Figure 11: Autozero confirm screen*

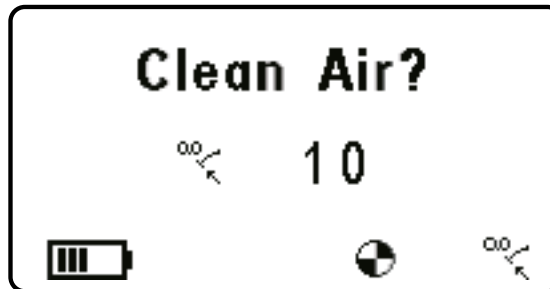

An Autozero should not be performed unless the Gas-Pro is in clean air. Press the operator button to enter the Autozero mode, otherwise the countdown will progress and will not perform a zero.

If the operator button is not pressed the countdown will complete and this function will be skipped.

When the autozero has finished or been skipped, the next screen is the home screen (*Figure 12*) and displays the gas levels.

The next screen on the Tank-Pro edition of Gas-Pro is the Tank Check  screen. See the Tank Check Mode section (see *Section 2.9* on *page 34*) for more information.

**Figure 12** shown below is for 5 gases in clean air.

Figure 12: Home screen

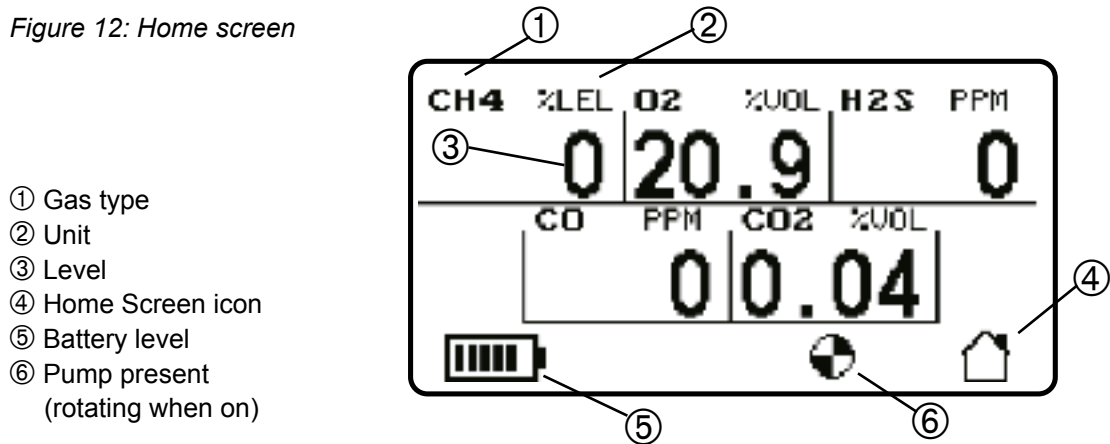

In 'clean air', CO<sub>2</sub> and Oxygen levels are typically 0.04% and 20.9% respectively. In zero mode, these gases will actually run an 'offset' zero.

The Gas-Pro is now ready for use.

**!** From the 1st November 2010, EN60079-29 part 1 has been harmonised under the ATEX directive 94/9/EC. Therefore to comply with the ATEX directive, portable apparatus sensing flammable gases should have a functional check with flammable gas before each day of use (see *Gas testing and calibration* on *page 37*). Other testing regimes may be employed depending on local circumstances.

## 2.3 Pump test

In the default configuration, a pumped Gas-Pro with a flow plate attached (see [Fitting a flow plate](#) on [page 12](#)) will run a pump test during the start up process. A pump test will also be run whenever a flow plate is attached during normal operation.

**If the Gas-Pro is configured for Bump functionality, the Bump/Pump prompt will be displayed if a flow plate is attached and a gas bump test is due or the Gas-Pro is placed in a Q-Test module during normal use (see [Bump/Pump functionality](#) on [page 33](#)).**

**Prior to fitting, the flow plate's gasket should be checked for any damage.**

The pump test ensures accurate sealing as well as monitoring pump performance.

The user will need to cover the pump inlet ① (see [Figure 13](#) below) when prompted to do so by the  symbol on the screen.

Figure 13: Pump inlet



When the test has finished, the pump will either pass ✓ or fail ✗.

If the pump test takes place during start-up and the Gas-Pro passes, the pump will remain on and the start-up process will continue as normal. If the test is passed during normal use, the Gas-Pro will remain in the pumped mode until the flow plate is removed.

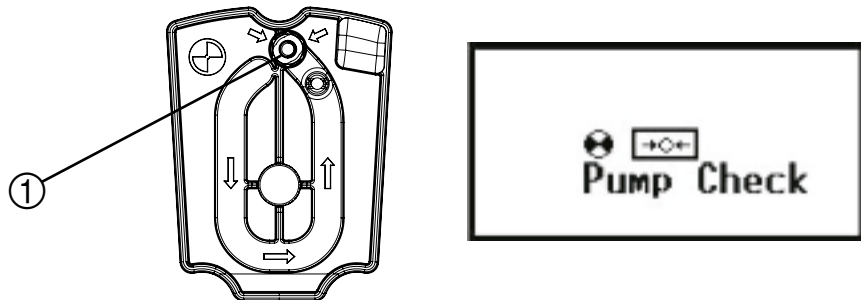
On failing the pump test the fail screen will persist with an audible alert until the button is pressed and the test repeats OR the flow plate is removed and the Gas-Pro returns to unpumped operation. For further detail on failing a pump test see [Pump test failure](#) on [page 48](#).

## 2.4 Detecting gas

When sampling an area that may contain water, use the ball float probe to reduce the potential for water travelling up the sample line.

### 2.4.1 Diffusion monitoring

If you wish to monitor gases in ambient air for dangerous levels, the Gas-Pro can be worn by either clipping the strong alligator clip to clothing/overalls in the breathing zone or through the use of a chest harness.

In the default, non-alarm state, Gas-Pro's sounder ① will emit a beep every 10 secs, its confidence LEDs ② will flash green, the +ve Safety™ indicator ③ will show the current status, and the LCD display ④ will indicate it is running by flashing the 🏠 icon.

Figure 14: Gas-Pro indicators

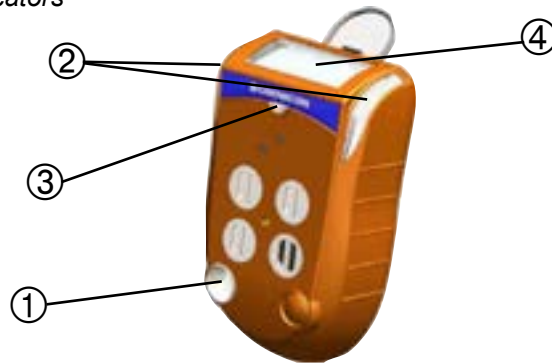

In the alarm state, Gas-Pro will vibrate, its sounder ① will emit a rapid tone, the alarm LEDs ② will flash red and blue, the +ve Safety™ indicator ③ will be off in alarm, the LCD display ④ will also be red and highlight the gas in alarm.

## 2.4.2 Pumped mode

Pumped operation requires the use of the pumped flow plate which automatically activates the pump (see [Bump/Pump functionality](#) on [page 33](#)). Gas-Pro can either be worn or used with hoses and probes to sample from spaces prior to entry. The pump capacity in the Gas-Pro is 0.5l/m and will draw a sample of gas from 30m within 80 seconds. Please note the expected losses for some gases below. Please allow at least 3 seconds per meter of hose used.

Tube Type		Standard (AC0201/03/05/10/20/30)					
Tube length		5 metres		10 metres		30 metres	
Measurement	Gas Name	Loss	Time	Loss	Time	Loss	Time
CO (250ppm)	Carbon Monoxide	0ppm	9 s	0ppm	20 s	1ppm	79 s
H <sub>2</sub> S (25ppm)	Hydrogen Sulphide	0ppm	10 s	1ppm	20 s	6ppm	78 s
CH <sub>4</sub> (2.5% VOL)	Methane	0% VOL	10 s	0% VOL	20 s	0% VOL	78 s
CO <sub>2</sub> (5% VOL)	Carbon Dioxide	0% VOL	9 s	0% VOL	20 s	0% VOL	79 s
O <sub>2</sub> (18% VOL)	Oxygen	0% VOL	9 s	0% VOL	20 s	0% VOL	79 s



**If Gas-Pro is operated in pumped mode in combination with an exhaust pipe, a set of bellows should be used inline (e.g. flow plate , 2cm maximum tube, bellows, 3000cm maximum tube).**

**Gas-Pro also has a specific pre-entry mode (see [Section 2.6.5](#) on [page 29](#)).**

## 2.4.3 Manual sampling

If the internal pump option has not been chosen the hand aspirator may be used for pre-entry checks and remote sampling. This is not however recommended for sample hoses longer than 5 meters due to the amount of time (and therefore squeezes) it would take to get a repeatable sample to the sensors. A water trap and filter should be used.

### 2.4.3.1 Using the Hand Aspirator

The hose end of the hand aspirator should be attached to the exhaust of the un-pumped flow plate, a sensors covered warning will be shown   and the user should accept this. The bulb should then be depressed whilst holding a finger over the inlet to ensure that a tight seal has been achieved. The detector will at this point likely go into alarm (this is due to the pressure effect on the oxygen sensor) and the bulb of the aspirator should not return to the rounded shape. If this does not happen – reposition the flow plate and repeat the test. Once the test is passed allow the O<sub>2</sub> sensor to stabilise to 20.9% and then attach the required sample hose length to the inlet on the flow plate and commence sampling. Depress the aspirator bulb every other second in order to get a constant sample flow to the sensors. Every depression of the aspirator bulb should pull the sample approximately 25cm up the tube. Therefore to sample from a 5 meter hose – at least 20 aspirations will be required, however a minimum of 1 minute is recommended to ensure a stable sample is read.

If the Gas-Pro being used is fitted with a carbon monoxide sensor (CO) a 5% increase in reading is expected during this process due to the extra pressure placed on the sensor (ie if the sample being tested is 30ppm – the expected result onscreen will show 32ppm).

If Gas-Pro is being used regularly for sampling, Crowcon strongly recommend the use of the internal pumped option to reduce time and potential for error.

 **Do not use the pumped flow plate for manual sampling.**

## 2.5 Alarms

The Gas-Pro has the following types of alarm:

- Low battery
- Instantaneous
- Time weighted average (TWA)



### 2.5.1 Low battery alarm

When the Gas-Pro warns of a low battery, the sounder will emit an audible double blip every 5 seconds and, if configured to do so, the +ve Safety™ LED will change state. This means the battery has at least 20 minutes of battery life remaining. After 20 minutes the Gas-Pro will enter full alarm state and the battery icon will flash empty.

- ! **Users should finish their current activity and move to a safe area as the instrument will power off without further warning unless charged.**



### 2.5.2 Instantaneous alarm

The Gas-Pro will go into alarm immediately if the level of any of the gases it is configured to detect become outside acceptable limits. A minimum and maximum acceptable level is set for oxygen, for most other gases the Gas-Pro will go into alarm state 1 or 2 according to which level has been exceeded.

In the alarm state, the 'bell' alarm symbol on the LCD screen will show a  or  to indicate which level of alarm has been triggered. In alarm, the sounder will emit a tone and the Gas-Pro will vibrate. The LEDs will flash red and blue, and the background of the LCD will change colour from green to red and the gas in alarm display will invert periodically. Symbols on the LCD will show the level and nature of the alarm.

### 2.5.3 Time weighted average alarm (TWA)

When activated, the Gas-Pro begins a new record for each toxic gas being monitored where it stores information about gas levels detected. If the average levels detected over a period of time exceeds predetermined levels, the Gas-Pro will go into alarm.

In the alarm state, the TWA symbol  on the LCD screen will indicate a 15 minute or 8 hour limit . The sounder will emit a tone and the Gas-Pro will vibrate. The LEDs will flash red and blue, and the background of the LCD display will change colour from green to red.

The LCD display will indicate the alarm has been triggered by exposure over time rather than instantaneously. Levels are set for a short period of 15 minutes and a longer one of 8 hours.

- ! **TWA alarms cannot be cleared. (The 8 hour TWA can be reviewed in the user menu - see [Section 2.6.4 on page 28](#)). The TWA can only be cleared by turning the Gas-Pro off (see [Shut down on page 32](#)). Refer to Health and Safety guidelines on TWA alarms.**
- ! **If TWA is monitored with the +ve safety™ configuration, the TWA +ve safety alert is only cleared by downloading the datalog via Portables Pro.**



## 2.5.4 Accepting and clearing alarms

Setting	Alarm 1	Alarm 2
Non-latched	Alarms will not be latched returning to non-alarm state without user acceptance	Alarm can be turned off only when gas has returned to acceptable levels
Latch Accept	Allows the user to silence alerts but remains in alarm. Once gas has returned to acceptable levels the user needs to accept the state.	Alarm can be turned off only when gas has returned to acceptable levels
Latched	Alarm can be turned off only when gas has returned to acceptable levels	Alarm can be turned off only when gas has returned to acceptable levels

**i** While in alarm, the Gas-Pro will continue to record levels of all the gases being monitored.

## 2.5.5 Sensor types

The Gas-Pro can be fitted with the following sensor types:

- Oxygen
- Electro-chemical
- Infra red (IR)
- Pellistor
- Photoionization Detector (PID)

### 2.5.5.1 Oxygen sensors

These sensors are in the form of an electro-galvanic fuel cell which is an electrical device used to measure the concentration of oxygen gas in the ambient air. Set as default with both higher and lower alarm levels.

### 2.5.5.2 Electro-chemical sensors

Electrochemical gas sensors measure the volume of a target gas by oxidising or reducing the target gas at an electrode and measuring the resulting current.

### 2.5.5.3 Infra red sensors

Gas is pumped or diffuses into the sample chamber, and gas concentration is measured electro-optically by its absorption of a specific wavelength in the infrared (IR).

#### 2.5.5.4 Pellistor sensors

Pellistor sensors (or catalytic beads) are specifically designed to sense explosive gases. The detecting element consists of small “pellets” of catalyst loaded ceramic whose resistance changes in the presence of gas.

#### 2.5.5.5 Pellistor saver mode

While in saver mode and the subsequent stabilise time, the gas level displayed on the LCD screen will indicate over range. If the alarm is so severe as to cause a sensor over-range the Gas-Pro should have a gas test to ensure no lasting damage has occurred.

Pellistor sensors can suffer degradation if powered while exposed to flammable gas concentrations of greater than 100% LEL, and also if exposed to high levels of H<sub>2</sub>S or silicones.

To reduce the degradation the instrument the Gas-Pro employs a Pellistor saver mode.

When the gas exceeds the saver threshold (user configurable: default 90% – 95%) then the detector will turn off the sensor for a minimum period of 3 minutes 20 seconds.

After this time the sensor can be re-activated by a single click of the operator button.

After a stabilisation time, if the gas level still exceeds the threshold then the sensor will be turned off and the cycle starts again.

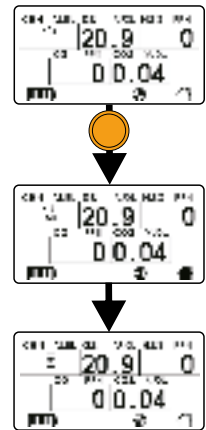

- ! From the 1st November 2010, EN60079-29 part 1 has been harmonised under the ATEX directive 94/9/EC. Therefore to comply with the ATEX directive, portable apparatus sensing flammable gases should have a functional check with gas before each day of use (see [Gas testing and calibration](#) on page 37). Other testing regimes may be employed depending on local circumstances.

### **2.5.5.6 PID**

PID sensors are configured and calibrated to Isobutylene when manufactured.

The PID sensor can be configured to detect Volatile Organic Compounds (VOC) other than Isobutylene by changing the correction factor in the PID sensor type options

Details of how to change the VOC correction factor can be found in Portables Pro user manual

Gas-Pro fitted with a PID sensor may require periodic cleaning and calibration of the sensor to ensure correct performance in normal use.







The sensor may need maintenance if any of the following occur:

- The baseline is climbing after zeroing the sensor
- The sensor becomes sensitive to humidity
- The baseline is unstable or shifts when the sensor is moved
- Sensitivity of the sensor has dropped

Please refer to Crowcon application note PID-AN-001 for further details on maintenance and cleaning of the PID sensor.

## 2.6 Gas-Pro functions

The following can be selected from the Gas-Pro user menu:

-  Home screen
-  Manual zero
-  Time weighted average (TWA) review
-  Pre-entry check
-  Peak review
-  Settings menu

### 2.6.1 Accessing the user menus

With the home screen displayed, double click the operator button to access the function menus.

Single click the operator button to scroll right until the required menu icon is highlighted and then double click to select the function.

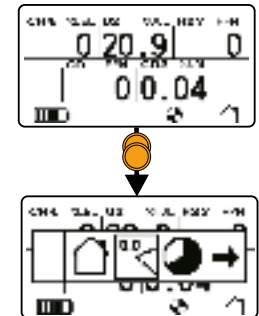

### 2.6.2 Home screen

When this icon is selected, the Home screen will be displayed.

### 2.6.3 Manual zero

This function should only be carried out in 'clean air' and allows the Gas-Pro to be zeroed at any time.

Certain operations will only take place if the Gas-Pro has been recently zeroed. For example, if configured to do so, Gas-Pro will progress to a calibration after failing a gas test if the unit has been manually zeroed in the last 15 minutes.

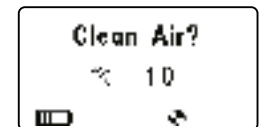

### 2.6.4 Time weighted average

This function allows the 8 hour TWA to be reviewed. For more details on the settings, see [Time weighted average alarm \(TWA\)](#) on [page 24](#).

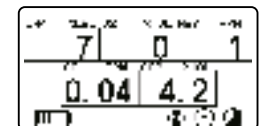

## 2.6.5 Pre-entry check (PEC)

This function is intended for sampling air of unknown quality before gaining access to it (e.g. going under ground through a manhole cover) thereby avoiding unnecessary exposure.

**The Gas-Pro (and any sampling probe) should be in a clean air when the PEC starts and finishes so the TWA accumulation should be insignificant.**

**If Gas-Pro is operated in pumped mode in combination with an exhaust pipe, a set of bellows should be used inline (e.g. flow plate , 2cm maximum tube, bellows, 3000cm maximum tube).**

PEC is a three stage process: sampling, peak and purge. There is a 5 minute timeout on each PEC stage, with a timeout moving the instrument through the stages – a timeout from the purge screen takes the instrument back to the home screen. This gives a total PEC timeout time of 15 minutes. This timing is deliberate: the STWA time period is 15 minutes so this ensures that if the gas level at the operator exceeds the level for an STWA alarm then the alarm will occur on completion of the PEC.

### 2.6.5.1 Starting a Pre-entry check

**If the Gas-Pro is in alarm, the Pre-entry check will not appear on the menu.**

Before you start the Pre-entry check, ensure you are ready to start the test (i.e. any flow plate, sampling probe or hand aspirator are fitted to the Gas-Pro as required).

From the home screen, double click the operator button to enter the menu selection screen.

Once there, single click to scroll to the right until Pre-entry check menu symbol  is highlighted with a box.

Double click to enter the PEC sampling stage.

A countdown screen will be displayed. Single click the operator button to start sampling. If the countdown finishes, the Gas-Pro will return to the home screen.

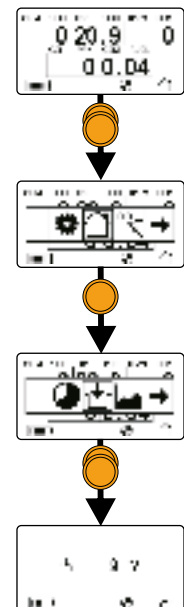

### 2.6.5.2 Carrying out a Pre-entry check

The Gas-Pro will remain in the sampling stage for a maximum of 5 minutes. Whilst the sampling screen is displayed, it will show the real time gas levels.

The alarms will continue to function during this stage and a single click of the operator button will accept these.

The PEC can be moved to the peak stage at any time before the 5 minute timeout by double clicking the operator button.

Peak readings registered during the Pre-entry check will be logged as events.

**Any peak reading sampled during this stage will not be added to the detector's cumulative monitoring data and thus will not affect the TWA calculations.**

The Gas-Pro will remain in the peak stage for a maximum of 5 minutes. When accessing the Peak Review screen the peak displayed will be the gas peak (trough for O<sub>2</sub>) seen in the selected time period; this will include gas levels seen during any PECs in the time period.

The PEC can be moved to the purge stage at any time before the 5 minute timeout by double clicking the operator button.

The Gas-Pro will remain in the purge stage for a maximum of 5 minutes.



**Before the purge stage ends, move to clean air.**

To end the purge stage at any time before the 5 minute timeout double click the operator button. A 10 second countdown screen will be displayed. To confirm the end of the purge stage single click the operator button within the 10 seconds or the purge will continue.

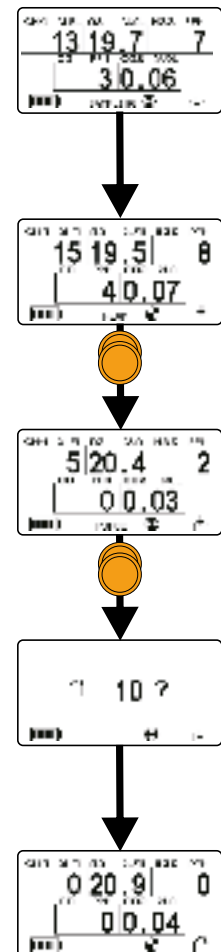
The Tank-Pro edition of Gas-Pro will not display %VOL readings while in PEC mode. See the Tank Check Mode  section (see [Section 2.9](#) on [page 34](#)) for more information.



## 2.6.6 Peak review

Select this option from the Menu Screen to see the highest level of each gas detected during the session. The menu offers the choice to display the peak gas level since the Gas-Pro was powered up , that occurred during the last 8 hours , or during the last 12 hours . There is also an option to clear current peak readings back to clean air values. The peaks are cleared when Gas-Pro is turned off.

## 2.6.7 Settings

The following settings can be altered by the user:

### 2.6.7.1 User setting



Up to 5 different users can be loaded into Gas-Pro using the Portables Pro PC application.

Double click the operator button to select the function. The screen will display the 5 user selectable icons (① to ⑤). Single click the operator button until the required user number is highlighted and then double click to select it. The screen will return to the settings menu and after a few seconds will display the home screen. Gas-Pro will create an event when the user is changed allowing traceability of the user.

### 2.6.7.2 Pump setting



This function, which is only present if the Gas-Pro has an internal pump, allows the user to turn the pump on or off.

Double click the operator button to select the function. Single click the operator button to highlight the required symbol (✓ to turn the pump on or ✗ to turn the pump off) and then double click. The screen will return to the settings menu and after a few seconds will display the home screen.

If a flow plate is attached a 'sensor covered' icon will be shown  .

### 2.6.7.3 Sounder volume

This function allows the user to change the sounder volume.

Double click the operator button to select the function. Single click the operator button to highlight the required symbol ( for high volume (98dB) or  for low volume (95dB)) then double click. The screen will return to the settings menu and after a few seconds will display the home screen.

## 2.7 Shut down

To turn the Gas-Pro off, press and hold the operator button. A 4 second countdown will start. Hold the button down until the countdown has finished and the Gas-Pro will shut down. If you release the button before the countdown has finished, the Gas-Pro will resume operation.

## 2.8 Additional Features

The Gas-Pro can be configured to allow and/or change the following features:

### 2.8.1 +ve Safety™

+ve Safety™ (Positive Safety) provides positive confirmation of detector status prior to deployment, in the field or on return from site.

The front mount tri-colour LED gives the Safety Manager or Supervisor the ability to see the status of the Operator's detector giving unrivalled visibility of the status of detectors deployed.

#### 2.8.1.1 +ve Safety™ indicator meanings

##### Green flash

Detector is compliant to the site or user specific requirements as set within the configuration.



##### Amber double flash

Detector is operational but requires attention. One or more of the pre-set flags has been triggered to change the status.



##### Red constant

Indicates the detector is not within the specified criteria for use and should not be used.



Gas-Pro is set at default to the 'Classic' setting but can be configured to organisational requirements through the use of Portables Pro and/or the I-Test.



## 2.8.2 Data and event logging

The data log records gas levels for all sensors and has capacity for 45,000 logs (125hrs @10 sec intervals). Threshold levels can be set using Portables Pro, extending log capabilities. The data log interval is set as part of the Gas-Pro configuration and can be adjusted using Portables Pro.

Event logging records significant events occurring during Gas-Pro operation.

Events include:

- On
- Configuration change
- User Acknowledgements
- Time change/set
- Alarm 1
- STWA
- Zero
- Gas Test
- Log upload (data/event)
- PEC Peaks
- Off
- Fault
- Low battery
- Pellistor saver
- Alarm 2
- LTWA
- Calibration
- Zero (auto or manual)
- PEC
- User changed



The event log has a capacity of at least 1000 events.

## 2.8.3 Bump/Pump functionality

If the Gas-Pro is configured for Bump/Pump functionality, then by placing the Gas-Pro in a Q-Test module or attaching a flow plate (with the Gas-Pro home screen displayed), the Bump/Pump screen will be displayed (see [Figure 15](#) below).

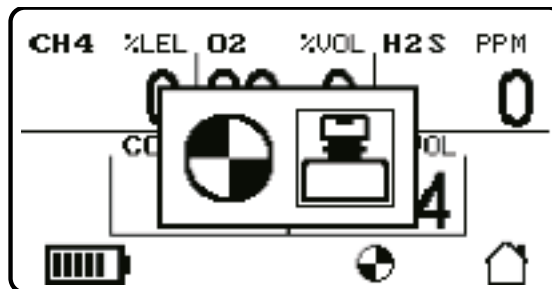
Figure 15: Bump/Pump screen



Click the operator button to highlight  for Pump or  for Bump testing and then double click to select (see [Pump test](#) on [page 20](#) or [Speedy bump](#) on [page 39](#) and [Smart bump](#) on [page 39](#) for Bump details).

## 2.9 Tank Check Mode

Tank Check Mode is unique to devices with a Dual-Range Flammable IR sensor fitted, or 'Tank-Pro' branded devices.

- ! **The device should under no circumstances be used as personal protection equipment whilst in Tank Check Mode.**
- ! **These devices will always display Tank Check Mode after start up has completed rather than the Home Screen.**

Alternatively, Tank Check Mode may be entered by selecting the Tank Check icon  from the device menu.

Figure 16: Tank Check Mode selection



Upon entry to Tank Check Mode, the device will display a confirmation message to inform that alarms are disabled. A single button press will dismiss this screen. The confirmation screen is accompanied by an intermittent warning tone.

Figure 17: Alarms disabled confirmation

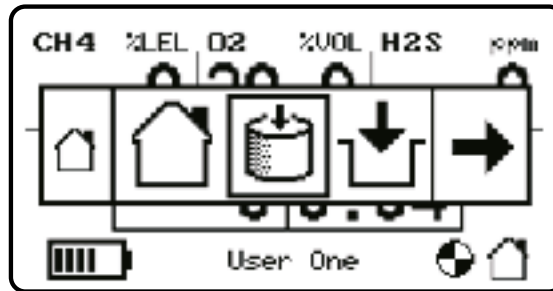
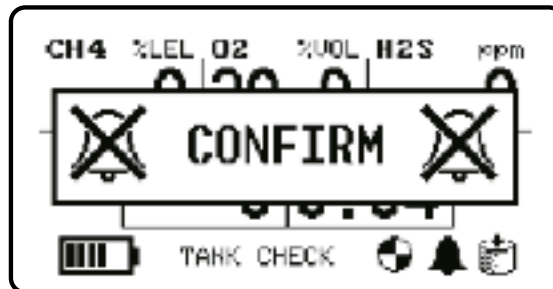

Tank Check Mode can be identified over the Home Screen as the text will be displayed in place of the current user name, the tank check icon will be displayed in the bottom-right corner, and the alarms disabled icon will be displayed to the left of the tank check icon.

Figure 18: Tank Check home page

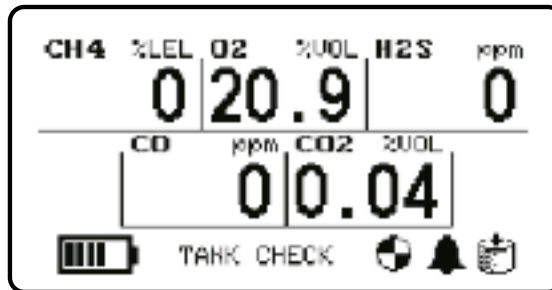

## 2.9.1 Dual-Range Operation

Tank Check Mode allows the Flammable IR sensor to display flammable gas readings in both %LEL and %VOL ranges.

When the flammable gas level is below 95%LEL, the measurement is displayed in %LEL range. Above 95% is displayed in %vol range.

When switching from %LEL to %VOL range, the device will play a rising range transition tone. When switching from %VOL to %LEL range, the device will play a falling range transition tone.

**%VOL is displayed as +/- 0.1% resolution up to 10%, and +/- 1% between 10-100%.**

## 2.9.2 Differences with Home Screen

There are several operational differences between the Home Screen and Tank Check Mode.

### 2.9.2.1 Instantaneous Alarms

Instantaneous alarms are disabled in Tank Check Mode. The device will not emit any alarm tone in Tank Check Mode.

### 2.9.2.2 TWA

TWA readings are not accumulated in Tank Check Mode, and TWA values are not available in the menu in Tank Check Mode.

### 2.9.2.3 Pre-Entry Check (PEC)

This mode is not accessible from the menu in Tank Check Mode.

#### **2.9.2.4 Confidence Tone**

The Tank Check Mode confidence tone is different to other operational modes to give an audible indication of the operating mode.

The Tank Check Mode confidence tone is four short 'pips' which are low pitch while in LEL range, and high pitch in VOL range.

#### **2.9.2.5 Display Backlight**

The display backlight is always illuminated in Tank Check mode.

## 3. Gas testing and calibration

### 3.1 Introduction

Crowcon recommends regular gas tests (also known as bump tests) to confirm sensor operation. This involves applying a known composition of the correct gas to each sensor to verify sensor response and alarm function. Organisational specific Health and Safety regulations should be adhered to, and a number of flexible and simple solutions are available.

Gas-Pro offers two types of bump test. A speedy bump test which is a gas test to the first alarm level and smart bump test, a gas test to a specified level of test gas.

In addition if any channel fails speedy bump or smart bump then Gas-Pro can be configured to perform a bump fail calibration.

Gas-Pro can be configured to automatically perform the following options:

- No Calibration or Bump (default configuration)
- Bump (Speedy or Smart)
- Bump then calibration after bump fail (calibration can be optional on a bump test pass)
- The configuration items differ per region and can be set with Portables Pro to match user requirements.

This bump test and calibration functionality can be implemented with of any of the following options.

#### Q-Test

Quick and simple in-field gas test and calibration solution. Providing off-site testing for remote locations where power is not always available or practical. Simple to use and easy to repeat Q-Test reduces set-up, training requirements and space needed.

Powered Q-Test allows gives a permanent home to monitors as it can be mounted in a vehicle and easily powered via a standard in-vehicle power socket.

#### I-Test

Intelligent wall or desk mount gas test and calibration solution. Suitable for small and large fleet users alike, I-Test offers simple fully managed testing with data capture as well as the ability to update configurations.

#### Flow Plate

Gas-Pro can also be tested simply by using the flow plate and applying gas.

**If Gas-Pro is operated in pumped mode in combination with an exhaust pipe, a set of bellows should be used inline (e.g. flow plate , 2cm maximum tube, bellows, 3000cm maximum tube)**

**!** From the 1st November 2010, EN60079-29 part 1 has been harmonised under the ATEX directive 94/9/EC. Therefore to comply with the ATEX directive, portable apparatus sensing flammable gases should have a functional check with gas before each day of use. Other testing regimes may be employed depending on local circumstances.

## 3.2 Bump Test Functionality

As part of the bump testing functionality Gas-Pro offers the ability to allocate gas sensors fitted to the Gas-Pro into different 'bump test groups'. These groups apply to both the speedy and smart bump functionality.

The groups available are 'Daily' and 'Intermittent', these can be configured via Portables Pro. This allows a different gas test regime to be applied for different sensors inline with site/company procedures. The information below explains this in greater detail:

If the sensors are grouped into the 'Intermittent'<sup>1</sup> group with, for example, a 90 day interval (this interval is configurable in Portables Pro), Gas-Pro will inform the user a bump test is due on the 90th day of use. This is indicated by a gas test due warning on the Gas-Pro screen during start up.

Figure 19: Gas test due screen

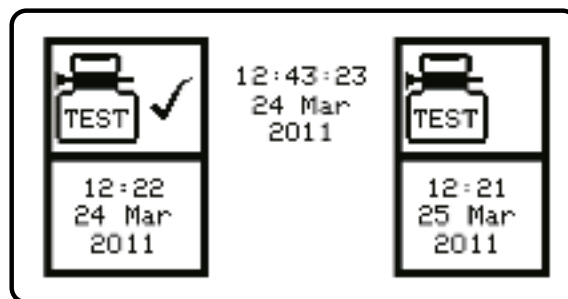

Gas-Pro will not inform the user of a need for a gas test until the interval period from the last successful bump has expired. However on applying a magnetised flow plate, or placing Gas-Pro into the Q-Test the user will be given the option to complete a gas test (or proceed to pumped operation).

If the sensors are grouped into the 'Daily' group, the Gas-Pro will inform the user a bump test is due at the start of each working day (actually every 24 hrs). This is indicated by a gas test due warning on the Gas-Pro screen during start up.

If Gas-Pro is turned off and on again within 24 hours of the gas test, the Gas-Pro will not inform the user of a need for a bump test. However on applying a magnetised flow plate, or placing Gas-Pro into the Q-Test the user will be given the option to complete a gas test (or proceed to pumped operation).

<sup>1</sup> The PID sensor can only be allocated to the 'intermittent' group; daily group is not available for PID sensors. The PID sensor must also be the only sensor in the intermittent group for the bump test functionality to operate correctly.

### 3.2.1 Speedy bump

A speedy bump tests the Gas-Pro to first alarm level.

Gas is presented across/over the sensor for a designated time (dependent on sensor gas type) during which alarm level one should be activated.

This is deemed a pass if the detector goes into alarm and the detector is functioning (sounder, LED's and vibrator, verified by the user).

It is a fail if the detector does not go into alarm.

#### 3.2.1.1 Procedure

- ▶ Either place the Gas-Pro in a Q-Test module or attach a flow plate to the Gas-Pro.
- ▶ Select Bump (see [Bump/Pump functionality on page 33](#)). The screen will show 'Gas on'.
- ▶ Attach the gas bottle and turn it on.
- ▶ After a time (depicted by a time bar at the base of the display), the display will show if the gas(es) being tested have passed ✓ or failed ✗. Gases not being tested will display [★]. The test will end before the preset time if all gases being tested pass.

### 3.2.2 Smart bump

A smart bump tests that the Gas-Pro responds correctly to a specified level of test gas.

Gas is passed over/across the sensors and a predicted response is expected within a time window dependant on the sensor response time.

The test is passed if the gas level indicated by the detector is within pre-specified limits within this time window (the parameters of this test are configurable via Portables Pro).

#### 3.2.2.1 Procedure

- ▶ Either place the Gas-Pro in a Q-Test module or attach a flow plate to the Gas-Pro.
- ▶ Select Bump (see [Bump/Pump functionality on page 33](#)). The screen will show 'Gas on'.
- ▶ Attach the gas bottle and turn it on.
- ▶ After a time (depicted by a time bar at the base of the display), the display will show if the gas(es) being tested have passed ✓ or failed ✗. Gases not being tested will display [★].

*(Note: Smart bump functionality is not available for the PID sensor. If Gas-Pro is configured for smart bump only a speedy bump will be performed on the PID sensor)*

### 3.2.3 Calibration after bump fail

If any channel fails speedy bump or smart bump then Gas-Pro can be configured (via Portables Pro) to perform a 'calibration after bump fail' immediately after the test failure.

**Calibration should only be performed with appropriately accurate gas.**

As this test immediately follows a speedy or smart bump, if 'calibration after bump fail' is configured the speedy or smart bump test will need to be undertaken with calibration quality gas.

**Ensure the gas applied matches the configuration settings in the Gas-Pro or the test will fail. This can be done via Portables Pro.**

**Should a flammable sensor be fitted, check the label for the original calibration target.**

#### 3.2.3.1 Procedure

- If calibration is intended, the instrument should have been zeroed manually within 15 minutes prior to the calibration attempt.
- Following a bump test failure, leave the instrument in the Q-test module or with the flow plate attached and the gas on.
- Wait for the calibration result screen indicated by the ✓ or ✗.
- The Gas-Pro then returns to normal operation.

During this process the new calibration values are stored to the instrument memory and the calibration dates are advanced by the configured interval – commonly 1 month as the Gas-Pro has not been through a formal service/calibration routine (dependent upon region/setting).

If the gas test calibration fails this may be indicative of a more serious sensor issue, including the need to replace sensors. The instrument should then be serviced.

### 3.3 New sensor calibration/service

Servicing or the fitment of a new sensor can only be undertaken by a suitably trained technician using the PC software and the appropriate gases.

In addition calibration should be performed as required by local or organisational regulations. In the absence of suitable evidence, such as a field assessment by a competent person, Crowcon recommend regular service and calibration every 6 months.



### 3.4 Gas test screen flow

The following sequence of screen shots should be viewed with reference to the sections on 'Speedy Bump', 'Smart Bump' & 'Calibration after bump fail'.





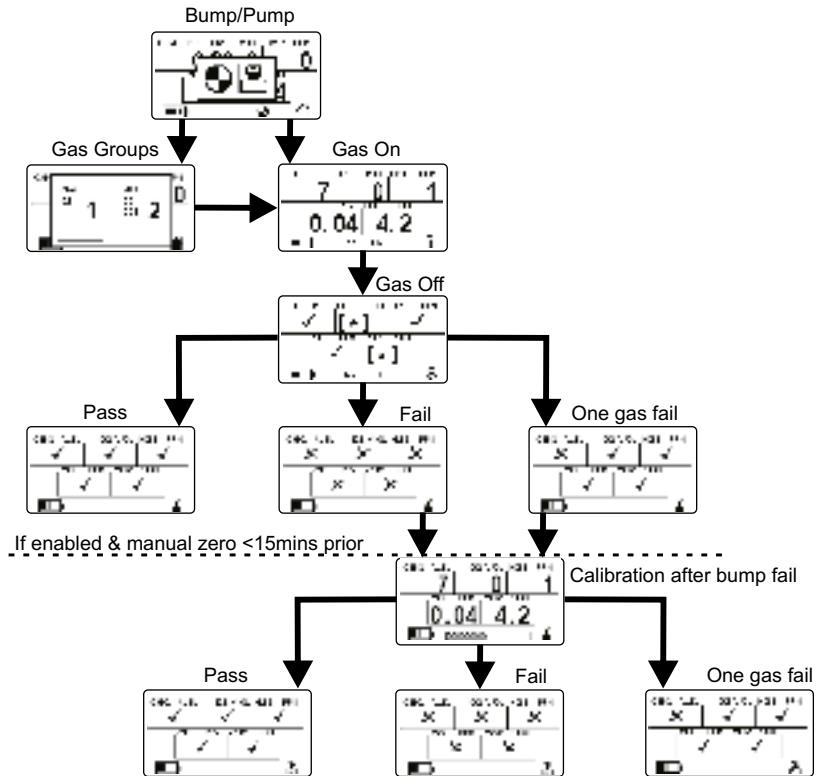













The screen shots show the general flow of the gas test functionality dependant upon the actual test and the decisions made.

Figure 20: Gas test screen flow



## 4. Icon overview

The table below details the icons shown during regular operation as well as warning messages. This table is intended as a quick overview please refer to specific functional sections within this manual for further details.

Icon	Description	Icon	Description
	Signifies 'home' screen		Indicates 'Battery' information
	Indicates 'Zero' functionality		Indicates a 'Warning' information
	Indicates 'Pre Entry Check' (PEC) functionality		Indicates 'Sounder' functionality
	Indicates 'Time Weighted Average' (TWA)		Indicates 'Settings ' functionality
	Indicates 'Pump' fitment/operation		Indicates 'Peak' functionality
	Indicates specified 'User'		Indicates a 'Gas Test' information
	Indicates 'Test Passed'		Indicates unit 'Off' functionality
	Time		Date
	Indicates 'Calibration' information		Indicates an 'Alarm'
	Indicates 'Tank Check' functionality		

## 5. Service and maintenance

Gas-Pro is designed to require minimal service and maintenance. As with all electrochemical sensors however, these will require periodic replacement.

- Ensure maintenance, service and calibration are carried out in accordance with the procedures in the manual and only by trained personnel.**

For further service or maintenance, contact your local Crowcon agent or regional office, for details reference the 'Contacts' section of the manual.

## 6. PC interface and Portables Pro

### 6.1 General

A number of differing variants of the software are available. The functionality of these variants ranges from viewing readings only, through to configuration and calibration. Please speak to Crowcon to determine which variant of software is appropriate for your requirements.

Gas-Pro has many configurable features, the majority of these can be set using PC interface software. The Gas-Pro is delivered with factory set regional defaults, for example:

- **Alarm 2:** latched
- **Volume:** standard (95 dB)
- **Pump/bump:** on
- **Bump:** on
- **Calibrate:** every 6 months
- **Autozero:** on
- **Confidence:** blip and flash
- **+ve Safety™:** 'Classic' setting

Please refer to the Calibration certificate supplied with the Gas-Pro for individual settings.

As well as displaying real time gas level data and signalling instantaneous and time weighted average alarms, the Gas-Pro records events and gas levels. Using the I-test available from Crowcon, or by connecting the Gas-Pro to a computer (see [Section 6.2, PC interface cable](#)), this data can be collected and viewed.

### 6.2 PC interface cable

Portables Pro allows the download and viewing of data and event logs from the Gas-Pro using an interface cable via the USB socket on a laptop or desktop computer.



 Please see Portables Pro instructions for details.

## 7. Accessories

Part Number	Description
CH0100	Multiregion power lead (includes CH0101 and CH0102)
CH0101	Multiregion power supply
CH0102	Charging lead
CH0103	USB communications lead (not powered)
CH0104	USB communication and power lead
CH0105	Gas-Pro charger cradle (no power)
CH0106	Vehicle charging adaptor (use with CH0102)
CH0107	5 Way multi-region power supply (Note: only for use with charging leads with serial numbers greater than Wxxxxx)
CH0200	INMETRO multi-region power lead (includes CH0101 and CH0202)
CH0202	INMETRO Charging lead
CH0203	INMETRO USB communications lead (not powered)
CH0204	INMETRO USB communication and power lead
AC0100	Gas-Pro pumped flow plate
AC0101	Gas-Pro unpumped flow plate
AC0201	1M Standard tubing (includes tube insert)
AC0203	3M Standard tubing (includes tube insert)
AC0205	5M Standard tubing (includes tube insert)
AC0210	10M Standard tubing (includes tube insert)
AC0220	20M Standard tubing (includes tube insert)
AC0230	30M Standard tubing (includes tube insert)
AC0500	Tube insert (connection from tube to flow plate) X 10
AC0511	Elbow tube insert (connection from tube to flow plate) X 10
AC0506	Chest harness plate
AC0507	Chest harness straps (2 per pack)
AC0508	Single strap
AC0509	6M Drop line (includes D-ring clip)
AC0501	Inline filter (for pumped units)
AC0502	Water trap including filter
AC0504	Hand aspirator bulb
SS0726	Exhaust Bellows

<b>Part Number</b>	<b>Description</b>
AC0301	1m reactive gas tubing (Tygothane® 3.2mm ID including tube insert)
AC0303	3m reactive gas tubing (Tygothane® 3.2mm ID including tube insert)
AC0512	Ball float probe
AC0103	Calibration flow plate for PC Calibration (no magnet)

## 8. Specification

Detector type	Multi-gas monitor
Gases*	O <sub>2</sub> , H <sub>2</sub> S, CO, CO <sub>2</sub> , FLAM Pellistor (CH <sub>4</sub> , C <sub>5</sub> H <sub>12</sub> , C <sub>3</sub> H <sub>8</sub> , C <sub>4</sub> H <sub>10</sub> , C <sub>2</sub> H <sub>4</sub> , C <sub>2</sub> H <sub>2</sub> , H <sub>2</sub> ), SO <sub>2</sub> , CL <sub>2</sub> , CLO <sub>2</sub> , NO, NO <sub>2</sub> , NH <sub>3</sub> , O <sub>3</sub> , PID, FLAM IR (CH <sub>4</sub> , C <sub>5</sub> H <sub>12</sub> , C <sub>3</sub> H <sub>8</sub> )
Size (d x l x w)	43 x 130 x 84 mm (1.7 x 5.1 x 3.3 inches)
Weight	5 gas (pump) 362g (12.7oz) 5 gas (un pumped) 333g (11.7oz) 4 gas (pump) 340g (11.9oz) 4 gas (un pumped) 309g (10.8oz)
Alarms	Audible >95dB Visual – all angle dual red/blue LEDs Vibrating alert +ve Safety™
Display	Top mount for ease of view viewable size 25 x 50 mm
Data logging	125hrs @10 second intervals (45,000 logs)
Event logging	Alarm, over range, calibration, bump, on/off, TWA, 1000 events
Battery	Rechargeable li-ion
Sampling	Internal pump as option Hand aspirator for non pumped
Operating temperature	-20°C to +55°C†
Storage	-25°C to +65°C (-13°F to +149°F)
Humidity	10 to 95 % RH◆
Ingress protection	Independently tested to IP65 and IP67‡
Approvals	<b>IECEX:</b> Ex d ia IIC T4 Gb Tamb -20°C to +55°C <b>ATEX:</b>  II 2 G Ex d ia IIC T4 Gb Tamb -20°C to +55°C <b>UL:</b> Gas detector use in hazardous locations Class 1 Division 1 Groups A, B, C and D only as to intrinsic safety <b>Marine Equipment Directive:</b>  Lloyds Certificate Number : MED 1500009/M2
Compliance	CE, FCC and ICES-003 Complies with EMC Directive 2004/108/EC
Interface	Data connection for use with calibration stations & direct to PC
Charging Options	Direct connect to multi-region power supply Car charging adapter USB interface cable USB power & communications cable 5 Way multi-region power supply

\* Gases not available in Gas-Pro with the internal pump option are CL<sub>2</sub>, CLO<sub>2</sub> & O<sub>3</sub>.

† Sensors may be degraded at the higher temperatures subject to individual sensor specifications

◆ Dependant upon sensor configuration

‡ Gas-Pro's fitted with a PID sensor are rated to IP65 only

## 9. Troubleshooting

### 9.1 Pump test failure

In the event of a pump test failure, check the following:

- Ensure a pumped flow plate was used for the test
- Remove the flow plate and check the gasket for damage (scratches, tears, etc.)
- Run the test again and ensure the test is carried out in the required time

If the pump still fails the test it may require servicing.

### 9.2 Fault screens

A fault screen (see [Figure 21](#) for an example) overwrites the normal screen.

Figure 21: Example fault screen

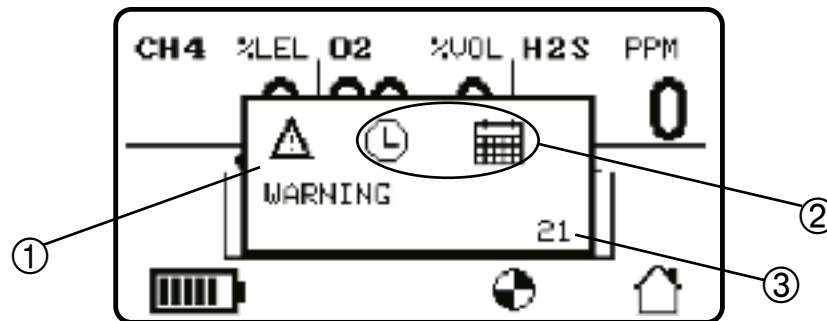







The warning triangle ① indicates faults that can be rectified by the user. The symbol is accompanied by the text “WARNING” below. The warning triangle is replaced by a spanner and screwdriver for faults which require service and the text “SERVICE” below. For the low battery warning the “WARNING” text is replaced by “ALERT”.







The clock and calendar ② indicates that this is a time and date fault. The icons vary for each fault some of which are illustrated below. These icons can be replaced by the gas name in the case of a fault associated with a gas channel.

Each fault has a fault code ③ (21 in this example).



## 9.2.1 Fault Descriptions

Fault codes	Symptom/Error Message	Icon	Cause	Action
0 or 9	Instrument won't switch on.	NA	Flat Battery.	Recharge battery.
N/A	No confidence beep/flash.	NA	Function disabled.	Reconfigure with PC software.
26 - 30, 58 - 62	Gas Reading with no gas present.	NA	Zero drifted.	Zero the instrument in clean air.
34 - 38, 50- 54, 58 - 62	Unstable/ inaccurate gas reading.	NA	Sensor failure.	Do not use; exit hazardous area immediately. Send instrument to authorised service agent.
26 - 30, 34 - 38, 50 - 54, 58 - 62	Autozero failed.		Zeroing in a contaminated atmosphere.	Switch off and restart in clean air.
26 - 30, 34 - 38, 50 - 54, 58 - 62	Cannot autozero due to alarm.		Zeroing in a contaminated atmosphere.	Switch off and restart in clean air.
67	Calibration Expired.		The calibration due date has passed.	Send instrument to authorised service agent.
25	Calibration Expired		The calibration due date has passed and "lock on cal due" has been configured which causes the monitor to go inoperable*.	Send monitor to authorised service agent for calibration.
69	The pump stops.		The Pump is blocked.	Clear the blockage.
70	N/A		The sensors are blocked by the flow plate.	Clear the blockage by removing the flow plate.

<b>Fault codes</b>	<b>Syptom/Error Message</b>	<b>Icon</b>	<b>Cause</b>	<b>Action</b>
0 or 9	Display shows empty battery symbol during startup.	 	Battery depleted.	Recharge battery.
73	Switched on and fully charged.	 	Unit full and on charge for over 12 hrs.	Remove Gas-Pro from charge.
N/A	Cannot switch off.		Instrument configured for "No switch off in alarm".	Move to clean air then switch off.
N/A	Charger is plugged in but no display.	NA	Battery has been deep discharged and insufficient charge to power up display.	Keep instrument on charge and eventually it will respond to single button push for quick view, after which it will display the charging symbol.
21	Time and Date error during startup.	 	Battery has been deep discharged and the internal clock has stopped.	Recharge battery. Then when charged correct the clock using the PC software.
N/A	Pump not active.	NA	The flow plate is not fitted and the pump is activated by the flow plate.	Fit the flow plate and select pump if necessary.
N/A	Pump fails check when activated.	NA	The pump check tests the pump suction and leaks in the gas path.	Check for the correct fitting of the flow plate and the seal of the gasket and tubing.  Re-activate the pump and block the gas path.
66	Gas Test Due.		The monitor has not been gas tested in the defined period.	The Gas Test is due.

<b>Fault codes</b>	<b>Syptom/Error Message</b>	<b>Icon</b>	<b>Cause</b>	<b>Action</b>
N/A	Bump Test Fail Lock.		The monitor has not been gas tested in the defined period and the gas test lock function has been activated.	The monitor needs calibration.
71	Battery low		Battery Low (about 20 to 30 minutes before switch off)	Exit the hazardous area as soon as possible and recharge battery.

### **9.2.2 Fault codes**

The following fault codes are not fixable by the user and the instrument should be sent to an authorised service agent:-

Fault code 4,5,6,7,8,11,12,13,14,15,16,17,19,20,25,26,27,28,29,30,50,51,52,53,54.

# 10. Appendices

## 10.1 Sensors

### 10.1.1 Toxic

Gas	Sensor part no	Range
CO/H <sub>2</sub> S	SS0300	0-500/0-100PPM
NH <sub>3</sub>	SS0306	0-100PPM
CL <sub>2</sub>	SS0305	0-5PPM
CLO <sub>2</sub>	SS0308	0-1PPM
SO <sub>2</sub>	SS0304	0-20PPM
O <sub>3</sub>	SS0309	0-1PPM
CO	SS0301	0-500PPM
CO	SS0301	0-2000PPM
CO	SS0302	0-2000PPM (H <sub>2</sub> Filtered)
H <sub>2</sub> S	SS0303	0-100PPM
NO	SS0310	0-100PPM
NO <sub>2</sub>	SS0311	0-20PPM
H <sub>2</sub> S	SS0404	0-1000PPM

## 10.1.2 Flammable Pellistor Sensors

Flammable sensors **MUST** only be used with the PCB P/N as detailed below in the ‘PCB P/N Suitability’ Column. Failure to do so may impair intrinsic safety and invalidate safety certification.

Gas	Sensor Part No.	Range	PCB P/N Suitability
Methane	SS0101	0-100% LEL	S013021, S013022, S013024
Pentane	SS0101	0-100% LEL	S013021, S013022, S013024
Butane	SS0101	0-100% LEL	S013021, S013022, S013024
Ethylene	SS0101	0-100% LEL	S013021, S013022, S013024
Propane	SS0101	0-100% LEL	S013021, S013022, S013024
Acetylene	SS0101	0-100% LEL	S013021, S013022, S013024
Hydrogen	SS0101	0-100% LEL	S013021, S013022, S013024

## 10.1.3 Flammable IR Sensors

Gas	Sensor Part No.	Range
Methane*	SS0201	0-100% LEL
Pentane*	SS0201	0-100% LEL
Propane*	SS0201	0-100% LEL
Butane*	SS0201	0-100% LEL

\* For Dual Range IR Gas-Pro & Tank Pro the same spare part number should be used as detailed above

## 10.1.4 Oxygen

Gas	Sensor Part No.	Range
O <sub>2</sub>	SS0500	0-25% VOL (2 years)
O <sub>2</sub>	SS0501	0-25% VOL (3 years)

## 10.1.5 IR

Gas	Sensor Part No.	Range
CO <sub>2</sub>	SS0280	0-5% VOL (2-5% for indication)

## 10.1.6 PID

Gas	Sensor Part No.	Range
PID	SS0600	0 -1000ppm

## 10.2 Sensor Limitations

The instrument is not suitable for use in ambient temperatures above 55°C and electrochemical toxic gas sensors may be degraded, reducing life at these temperatures. Water should not be allowed to collect on the sensors as this may impede gas diffusion. Use with care in wet or humid environments where water may condense on the sensors, and check response after use.

Persistent exposure to high levels of toxic gas can shorten the life of toxic sensors. Toxic sensors may also be cross-sensitive to gases other than their specific target gas, and hence the presence of other gases may cause the sensor to respond. If unsure, contact Crowcon or your local agent.

Use of high power radio transmitters in close proximity to the instrument may exceed RFI immunity levels and cause erroneous indications. If such problems are experienced, remove antennae to a reasonable distance from the instrument (e.g. 30 cm).

Standard units detect flammable gases using a catalytic flammable sensor which operates in the presence of oxygen. It is advisable to check the oxygen concentration as well as the flammable gas concentration before entering a confined space. Oxygen levels below 10% will reduce a flammable gas reading.

The performance of catalytic sensors may be permanently degraded if exposed to silicones, sulphur containing gases (such as H<sub>2</sub>S), lead or chlorine compounds (including chlorinated hydrocarbons).

The performance of the PID sensor depends on the environment that is being measured. If measuring high VOC concentrations where particulates are present in high concentrations check calibration frequently and if the sensor has lost sensitivity, refer to the application note PID-AN-001 for maintenance instructions.

### 10.3 Charging and run times

The table below indicates run times which can be expected following a full charge discharge cycle.

<b>Configuration</b>	<b>Run Time</b>
O <sub>2</sub> ,CO/H <sub>2</sub> S, Pellistor, CO <sub>2</sub> (IR)	11 hrs
Pumped O <sub>2</sub> ,CO/H <sub>2</sub> S, Pellistor, CO <sub>2</sub> (IR)	10 hrs
O <sub>2</sub> ,CO/H <sub>2</sub> S, Pellistor	14 hrs
Pumped O <sub>2</sub> ,CO/H <sub>2</sub> S, Pellistor	13 hrs

Run time is equal to the expected operating time following a full charge/discharge cycle.

Should the Gas-Pro completely discharge, charge within 3 days. This will maintain the internal clock.

Gas-Pro in a fully charged state will last for 3 months from new.

## 10.4 Contacts

**UK:** Crowcon Detection Instruments Ltd, 172 Brook Drive, Milton Park, Abingdon, Oxfordshire OX14 4SD

**Tel:** +44 (0) 1235 557700

**Fax:** +44 (0) 1235 557749

**Email:** sales@crowcon.com

**US:** Crowcon Detection Instruments Ltd, 1455 Jamike Ave, Suite 100, Erlanger, KY 41018

**Tel:** +1 859 957 1039 or 1 800 527 6926

**Fax:** +1 859 957 1044

**Email:** salesusa@crowcon.com

**NL:** Crowcon Detection Instruments Ltd, Vlambloem 129, 3068JG, Rotterdam, Netherlands

**Tel:** +31 10 421 1232

**Fax:** +31 10 421 0542

**Email:** eu@crowcon.com

**SG:** Crowcon Detection Instruments Ltd, Block 194, Pandan Loop, #06-20 Pantech Industrial Complex, Singapore, 128383

**Tel:** +65 6745 2936

**Fax:** +65 6745 0467

**Email:** sales@crowcon.com.sg

**CN:** Crowcon Detection Instruments Ltd (Beijing), Unit 316, Area 1, Tower B, Chuangxin Building, 12 Hongda North Road, Beijing Economic & Technological Development Area, Beijing, China 100176

**Tel:** +86 10 6787 0335

**Fax:** +86 10 6787 4879

**Email:** saleschina@crowcon.com

[www.crowcon.com](http://www.crowcon.com)



# Warranty

This equipment leaves our factory fully tested and calibrated. If within the warranty period of two years from despatch, the equipment which includes pump, battery and common sensors (see sensor chart below) is proved to be defective by reason of faulty workmanship or material, we undertake at our option either to repair or replace it free of charge, subject to the conditions below.

## Battery Warranty

All batteries degrade in performance over time and usage. For the purpose of this warranty it is considered that two years use equates to 500 full charge / discharge cycles (fully empty to full) and users should expect to see no greater than a 20% decline in run time after either this time or number of cycles, whichever is sooner.

## Sensor Warranty

Sensor	Warranty	Expected Life
Oxygen (2 yr)	2 years	2 years
Oxygen (3 yr)	3 years	3 years
Dual hydrogen sulphide and carbon monoxide	2 years	>24 months
Flammable (pellistor)	2 years	Up to 5 years in air
Flammable (IR)	2 years	> 5 years
Carbon dioxide (IR)	2 years	> 5 years
Ammonia	1 year	>2 years
Chlorine	1 year	>2 years
Chlorine dioxide	1 year	>2 years
Sulphur dioxide	2 years	>2 years
Ozone	1 year	>1.5 years
Carbon monoxide	2 years	>2 years
Hydrogen sulphide	2 years	>2 years
Nitric oxide	2 years	>2 years
Nitrogen dioxide	2 years	>2 years
PID		
Electronics & housing	2 years	2 years
Lamp & electrode stack	6 months	6 months

## **Warranty Procedure**

To facilitate efficient processing of any claim, contact your local Crowcon agent/distributor, a Crowcon regional office or our global customer support team (English working language) on +44 (0)1235 557711 or [customersupport@crowcon.com](mailto:customersupport@crowcon.com) to obtain a returns form for identification and traceability purposes. This form may be downloaded from our website '[crowconsupport.com](http://crowconsupport.com)' and requires the following information:

- Your company name, contact name, phone number and email address.
- Description and quantity of goods being returned, including any accessories.
- Instrument serial number(s).
- Reason for return.

Gas-Pro will not be accepted for warranty without a Crowcon Returns Number (CRN). It is essential that the address label is securely attached to the outer packaging of the returned goods.

The guarantee will be rendered invalid if the instrument is found to have been altered, modified, dismantled, tampered with, or has not used Crowcon spares for replacement parts (including sensors) or has been serviced or repaired by any party not authorised and certified by Crowcon to do so. The warranty does not cover misuse or abuse of the unit including use outside of specified limits.

## **Warranty Disclaimer**

Crowcon accept no liability for consequential or indirect loss or damage howsoever arising (including any loss or damage arising out of the use of the instrument) and all liability in respect of any third party is expressly excluded.

This warranty does not cover the accuracy of the calibration of the unit or the cosmetic finish of the product. The unit must be maintained in accordance with the instructions in this manual.

The warranty on replacement consumable items supplied under warranty to replace faulty items, will be limited to the unexpired warranty of the original supplied item.

Crowcon reserves the right to determine a reduced warranty period, or decline a warranty period for any sensor supplied for use in an environment or for an application known to carry risk of degradation or damage to the sensor.

Our liability in respect of defective equipment shall be limited to the obligations set out in the guarantee and any extended warranty, condition or statement, express or implied statutory or otherwise as to the merchantable quality of our equipment or its fitness for any particular purpose is excluded except as prohibited by statute. This guarantee shall not affect a customer's statutory rights.

Crowcon reserves the right to apply a handling and carriage charge whereby units returned as faulty, are found to require only normal calibration or servicing, which the customer then declines to proceed with.

For warranty and technical support enquiries please contact:

**Customer Support**

**Tel: +44 (0) 1235 557711**

**Fax: +44 (0) 1235 557722**

**Email: [customersupport@crowcon.com](mailto:customersupport@crowcon.com)**